

Article number: 54301320

Description: LDK Rod end PHS 20

Measures

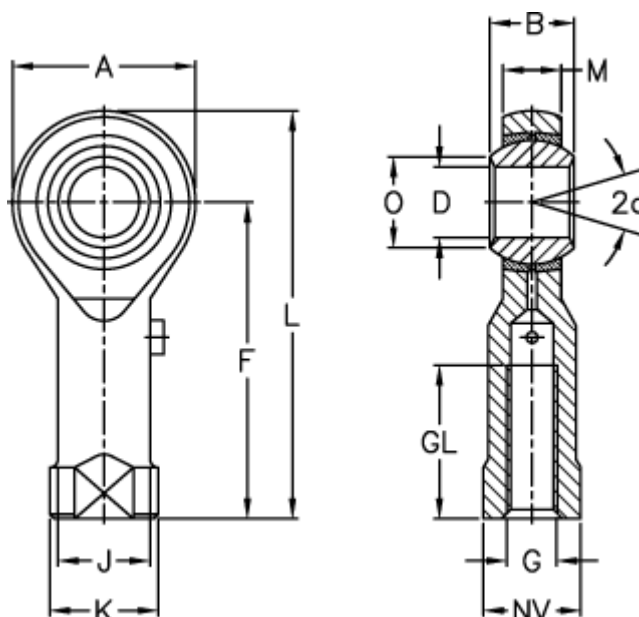

A	= 46	J	= 27.5
a (degrees)	= 14	K	= 34
B	= 25	L	= 100
D	= 20	M	= 18.00
Dynamic load C (kN)	= 23.0	NV	= 30
F	= 77	O	= 24.30
g	= M20x1,5	Static load C0 (kN)	= 50.0
GL	= 40	Weight (g)	= 380.0